







BẢNG GIÁ THIẾT BỊ ĐÓNG NGẮT FUJI ELECTRIC T4/2026

MCB	Mã hàng	Icu (kA)	Dòng định mức (A)	Đơn giá VND
MCB 1P 6kA				
	BCL63E0CG-1P	6kA	2, 4	157,000
			6, 10, 16, 20, 25, 32	114,000
			40, 50, 63	128,000
MCB 2P 6kA				
	BCL63E0CG-2P	6kA	2,4	345,000
			6, 10, 16, 20, 25, 32	254,000
			40, 50, 63	262,000
MCB 3P 6kA				
	BCL63E0CG-3P	6kA	2,4	518,000
			6, 10, 16, 20, 25, 32	408,000
			40, 50, 63	416,000
MCB 4P 6kA				
	BCL63E0CG-4P	6kA	2,4	691,000
			6, 10, 16, 20, 25, 32	586,000
			40, 50, 63	612,000

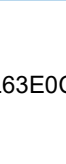

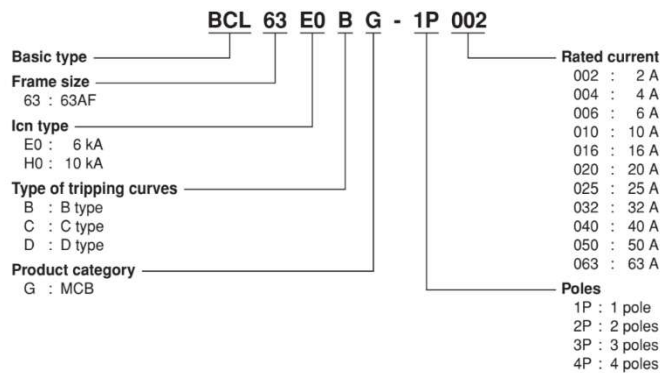

Diễn giải mã hàng:

MCB

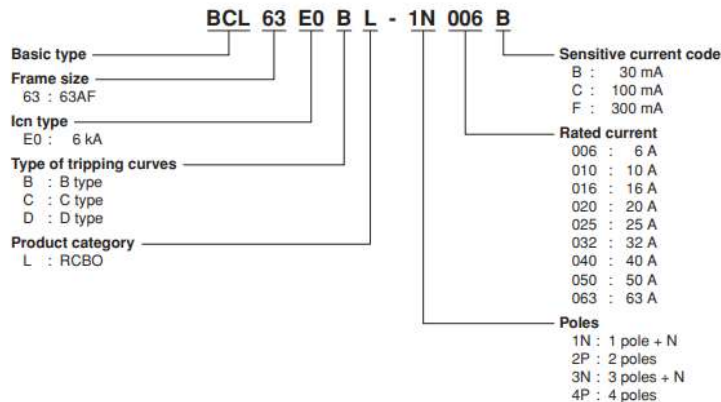

RCBO





MCB	Mã hàng	Icu (kA)	Dòng định mức (A)	Đơn giá VND
MCB 1P 10kA				
	BCL63H0CG-1P006	10kA	6	332,000
	BCL63H0CG-1P010		10	319,000
	BCL63H0CG-1P016		16	319,000
	BCL63H0CG-1P020		20	314,000
	BCL63H0CG-1P025		25	309,000
	BCL63H0CG-1P032		32	358,000
	BCL63H0CG-1P040		40	409,000
	BCL63H0CG-1P050		50	422,000
	BCL63H0CG-1P063		63	426,000
MCB 2P 10kA				
	BCL63H0CG-2P006	10kA	6	672,000
	BCL63H0CG-2P010		10	645,000
	BCL63H0CG-2P016		16	645,000
	BCL63H0CG-2P020		20	633,000
	BCL63H0CG-2P025		25	619,000
	BCL63H0CG-2P032		32	721,000
	BCL63H0CG-2P040		40	826,000
	BCL63H0CG-2P050		50	855,000
	BCL63H0CG-2P063		63	860,000
MCB 3P 10kA				
	BCL63H0CG-3P006	10kA	6	1,005,000
	BCL63H0CG-3P010		10	963,000
	BCL63H0CG-3P016		16	963,000
	BCL63H0CG-3P020		20	944,000
	BCL63H0CG-3P025		25	928,000
	BCL63H0CG-3P032		32	1,077,000
	BCL63H0CG-3P040		40	1,233,000
	BCL63H0CG-3P050		50	1,278,000
	BCL63H0CG-3P063		63	1,286,000
MCB 4P 10kA				
	BCL63H0CG-4P006	10kA	6	1,306,000
	BCL63H0CG-4P010		10	1,252,000
	BCL63H0CG-4P016		16	1,252,000
	BCL63H0CG-4P020		20	1,227,000
	BCL63H0CG-4P025		25	1,207,000
	BCL63H0CG-4P032		32	1,399,000
	BCL63H0CG-4P040		40	1,604,000
	BCL63H0CG-4P050		50	1,662,000
	BCL63H0CG-4P063		63	1,673,000

RCBO	Mã hàng	Icu (kA)	Dòng định mức (A)	Đơn giá VND
RCBO 1P+N - Dòng rò 10mA, 30mA, 100mA				
	BCL63E0CL-1N006B	6kA	6	1,520,000
	BCL63E0CL-1N010B		10	1,520,000
	BCL63E0CL-1N016B		16	1,520,000
	BCL63E0CL-1N020B		20	1,520,000
	BCL63E0CL-1N025B		25	1,926,000
	BCL63E0CL-1N032B		32	1,926,000
	BCL63E0CL-1N040B		40	1,976,000
	BCL63E0CL-1N050B		50	1,976,000
	BCL63E0CL-1N063B		63	1,976,000
RCBO 2P - Dòng rò 10mA, 30mA, 100mA				
	BCL63E0CL-2P006B	6kA	6	2,234,000
	BCL63E0CL-2P010B		10	2,234,000
	BCL63E0CL-2P016B		16	2,234,000
	BCL63E0CL-2P020B		20	2,234,000
	BCL63E0CL-2P025B		25	2,234,000
	BCL63E0CL-2P032B		32	2,234,000
	BCL63E0CL-2P040B		40	2,311,000
	BCL63E0CL-2P050B		50	2,311,000
	BCL63E0CL-2P063B		63	2,311,000
RCBO 3P+N - Dòng rò 10mA, 30mA, 100mA				
	BCL63E0CL-3N006B	6kA	6	2,442,000
	BCL63E0CL-3N010B		10	2,442,000
	BCL63E0CL-3N016B		16	2,442,000
	BCL63E0CL-3N020B		20	2,442,000
	BCL63E0CL-3N025B		25	2,442,000
	BCL63E0CL-3N032B		32	2,442,000
	BCL63E0CL-3N040B		40	2,472,000
	BCL63E0CL-3N050B		50	2,472,000
	BCL63E0CL-3N063B		63	2,472,000
RCBO 4P - Dòng rò 10mA, 30mA, 100mA				
	BCL63E0CL-4P006B	6kA	6	3,385,000
	BCL63E0CL-4P010B		10	3,385,000
	BCL63E0CL-4P016B		16	3,385,000
	BCL63E0CL-4P020B		20	3,385,000
	BCL63E0CL-4P025B		25	3,385,000
	BCL63E0CL-4P032B		32	3,385,000
	BCL63E0CL-4P040B		40	3,537,000
	BCL63E0CL-4P050B		50	3,537,000
	BCL63E0CL-4P063B		63	3,537,000

MCCB	Mã hàng	Icu tại AC400V (kA)	Dòng định mức (A)	Kích thước (mm)			Đơn giá VND
				Dài	Rộng	Cao	
MCCB 2P							
	BW32AAG-2P	2.5	5, 10, 15, 20, 30, 32	100	50	60	562,000
	BW50EAG-2P	5	5, 10, 15, 20, 30, 40, 50				862,000
	BW63EAG-2P	5	60, 63				867,000
	BW100EAG-2P	10	75, 100				1,420,000
MCCB 3P							
 	BW32AAG-3P	1.5	5, 10, 15, 20, 32	100	75	60	824,000
	BW50EAG-3P	2.5	5, 10, 15, 20, 30, 40, 50				958,000
	BW50SAG-3P	7.5					1,100,000
	BW50RAG-3P	10					1,222,000
	BW63EAG-3P	2.5					60, 63
	BW63SAG-3P	7.5	1,100,000				
	BW63RAG-3P	10	1,222,000				
	BW100EAG-3P	10	50, 60, 63,75,100				1,684,000
	BW103E0	18	75,100				1,980,000
	BW125JAG-3P	30	15, 20, 30, 40, 50, 60, 75,100,125				2,518,000
	BW125SAG-3P	36		3,850,000			
	BW125HAG-3P	65		9,013,000			
	BW163E0	18	125, 150, 160	2,911,000			
	BW163S0	36		3,982,000			
	BW253E0	18	175, 200, 225, 250	2,911,000			
	BW253S0	36		4,267,000			
	BW250HAG-3P	65	175, 200, 225, 250	11,558,000			
	BW403S0	36	250,300, 350, 400	6,647,000			
	BW400RAG-3P	50		9,704,000			
	BW400HAG-3P	70		23,704,000			
BW630EAG-3P	36	500, 600, 630	12,393,000				
BW630RAG-3P	50		12,938,000				
BW630HAG-3P	70		36,192,000				
BW800EAG-3P	36		700, 800	20,288,000			
BW800RAG-3P	50	21,831,000					
BW800HAG-3P	70	53,769,000					

MCCB	Mã hàng	Icu tại AC400V (kA)	Dòng định mức (A)	Kích thước (mm)			Đơn giá VND
				Dài	Rộng	Cao	
MCCB 4P							
	BW125JAG-4P	30	15, 20, 30, 40, 50, 60, 75, 100, 125	155	120	68	4,278,000
	BW125SAG-4P	36					6,288,000
	BW125RAG-4P	50					7,126,000
	BW160JAG-4P	30	125, 150, 160	165	140	68	4,752,000
	BW160SAG-4P	36					8,859,000
	BW160RAG-4P	50					9,413,000
	BW250JAG-4P	30	175, 200, 225, 250	165	140	68	7,319,000
	BW250SAG-4P	36					10,292,000
	BW250RAG-4P	50					10,382,000
	BW400RAG-4P	50	250, 300, 350, 400	257	185	103	12,488,000
	BW400HAG-4P	70	250, 300, 350, 400				41,709,000
	BW630RAG-4P	50	500, 600, 630	275	280	103	43,782,000
	BW630HAG-4P	70	500, 600, 630				98,985,000
	BW800RAG-4P	50	700, 800				64,791,000
	BW800HAG-4P	70	700, 800				147,041,000

MCCB chỉnh dòng	Mã hàng	Icu tại AC400V (kA)	Dòng định mức (A)	Kích thước (mm)			Đơn giá VND
				Dài	Rộng	Cao	
MCCB 3P dòng BW-CF: Dải điều chỉnh dòng 0.7-1 In							
	BW100ECF-3P	25	16, 25, 32, 40, 50, 63, 80, 100	161	105	86	4,083,000
	BW160ECF-3P	25	125, 160	161	105	86	8,281,000
	BW250ECF-3P	25	200, 250	161	105	86	8,722,000
	BW100SCF-3P	36	16, 25, 32, 40, 50, 63, 80, 100	161	105	86	6,828,000
	BW160SCF-3P	36	125, 160	161	105	86	9,270,000
	BW250SCF-3P	36	200, 250	161	105	86	11,123,000
	BW400SCF-3P	36	320, 400	255	140	110	14,837,000
	BW630SCF-3P	36	500, 600	255	140	110	25,340,000
	BW400RCF-3P	50	320, 400	255	140	110	18,100,000
BW630RCF-3P	50	500, 600	255	140	110	30,525,000	
MCCB 4P dòng BW-CF: Dải điều chỉnh dòng 0.7-1 In							
	BW100ECF-4P	25	16, 25, 32, 40, 50, 63, 80, 100	161	140	86	5,812,000
	BW160ECF-4P	25	125, 160	161	140	86	11,123,000
	BW250ECF-4P	25	200, 250	161	140	86	12,728,000
	BW100SCF-4P	36	16, 25, 32, 40, 50, 63, 80, 100	161	140	86	8,831,000
	BW160SCF-4P	36	125, 160	161	140	86	12,444,000
	BW250SCF-4P	36	200, 250	161	140	86	14,456,000
	BW400SCF-4P	36	320, 400	255	185	110	23,966,000
	BW630SCF-4P	36	500, 600	255	185	110	75,773,000
	BW400RCF-4P	50	320, 400	255	185	110	23,966,000
	BW630RCF-4P	50	500, 600	255	185	110	75,773,000

MCCB chỉnh dòng	Mã hàng	Icu tại AC400V (kA)	Dòng định mức (A)	Kích thước (mm)			Đơn giá VND
				Dài	Rộng	Cao	
MCCB 3P dòng BX: Dải điều chỉnh dòng 0.4-1 In							
	BX1000RAE-3P	50	1,000	327	210	147	66,116,000
	BX1250RAE-3P	50	1,250	327	280	147	61,959,000
	BX1600RAE-3P	50	1,600	327	210	147	73,831,000
	BX1000HAE-3P	70	1,000	327	210	147	73,817,000
	BX1250HAE-3P	70	1,250	327	280	147	71,992,000
	BX1600HAE-3P	70	1,600	327	210	147	100,042,000
MCCB 4P dòng BX: Dải điều chỉnh dòng 0.4-1 In							
	BX1000RAE-4P	50	1,000	327	280	147	78,977,000
	BX1250RAE-4P	50	1,250	327	210	147	75,254,000
	BX1600RAE-4P	50	1,600	327	280	147	94,242,000
	BX1000HAE-4P	70	1,000	327	280	147	117,892,000
	BX1250HAE-4P	70	1,250	327	210	147	114,315,000
	BX1600HAE-4P	70	1,600	327	280	147	130,584,000

ELCB	Mã hàng	Icu tại AC400V (kA)	Dòng định mức (A)	Kích thước (mm)			Đơn giá VND
				Dài	Rộng	Cao	
ELCB 2P (Chỉ dùng cho điện áp lên đến 230V AC)							
	EW32AAG-2P ⁽¹⁾	2.5	5,10,15,20,30,32	100	50	60	2,402,000
	EW50AAG-2P ⁽¹⁾	2.5	5,10,15,20,30,40,50				2,448,000
ELCB 3P dòng cắt thấp (kinh tế)							
	EW32EAG-3P ⁽¹⁾	1.5	5,10,15,20,30,32	100	75	60	3,623,000
	EW50EAG-3P ⁽²⁾	2.5	5,10,15,20,30,40,50				2,939,000
	EW63EAG-3P ⁽²⁾	2.5	60, 63				4,440,000
	EW100EAG-3P ⁽³⁾	10	60,63,75,100	165	105	68	4,683,000
	EW160EAG-3P ⁽⁴⁾	18	125, 150, 160				11,947,000
	EW250EAG-3P ⁽⁴⁾	18	175, 200, 225, 250				12,682,000
	EW400EAG-3P ⁽⁴⁾	30	250, 300, 350, 400	257	140	103	28,342,000
	EW630EAG-3P ⁽⁴⁾	36	500, 600, 630	275	210	103	65,458,000
	EW800EAG-3P ⁽⁴⁾	36	700, 800				82,457,000

Chú thích:

- (1): 15,30,100mA
- (2): 15,30,100/200mA
- (3): 30,100/200/500mA
- (4): 30,100/300/500/1000mA

Mã dòng rò bảo vệ:

- A: 15mA - B: 30mA - C: 100mA - D: 50mA
- J: 100/300/500/1000mA
- K: 100/200mA, 100/200/500mA, 100/200/500/1000mA

ELCB	Mã hàng	Icu tại AC400V (kA)	Dòng định mức (A)	Kích thước (mm)			Đơn giá VND
				Dài	Rộng	Cao	
ELCB 3P dòng cắt tiêu chuẩn							
	EW32SAG-3P ⁽³⁾	2.5	5,10,15,20,30,32	100	75	60	4,440,000
	EW50SAG-3P ⁽³⁾	7.5	5,10,15,20,30,40,50				6,842,000
	EW63SAG-3P ⁽³⁾	7.5	60, 63				6,573,000
	EW125JAG-3P ⁽⁴⁾	30	15,20,30,40,50,60,75,100, 125	155	90	68	13,769,000
	EW125SAG-3P ⁽⁴⁾	36	15,20,30,40,50,60,75,100, 125				14,596,000
	EW160SAG-3P ⁽⁴⁾	36	125, 150, 160	165	105	68	21,248,000
	EW250SAG-3P ⁽⁴⁾	36	175, 200, 225, 250				23,690,000
	EW400SAG-3P ⁽⁴⁾	36	250, 300, 350, 400	257	140	103	34,375,000
	EW630RAG-3P ⁽⁴⁾	50	500, 600, 630	275	210	103	71,350,000
	EW800RAG-3P ⁽⁴⁾	50	700, 800				88,655,000
ELCB 3P dòng cắt cao							
	EW50RAG-3P ⁽³⁾	10	5,10,15,20,30,40,50	100	75	60	7,827,000
	EW63RAG-3P ⁽³⁾	10	60, 63				7,520,000
	EW125RAG-3P ⁽⁴⁾	50	15,20,30,40,50,60,75,100, 125	155	90	68	15,871,000
	EW160RAG-3P ⁽⁴⁾	50	125, 150, 160	165	105	68	22,662,000
	EW250RAG-3P ⁽⁴⁾	50	175, 200, 225, 250				25,380,000
	EW400RAG-3P ⁽⁴⁾	50	250, 300, 350, 400	257	140	103	58,994,000
	EW630HAG-3P ⁽⁴⁾	70	500, 600, 630	275	210	103	81,109,000
	EW800HAG-3P ⁽⁴⁾	70	700, 800				101,934,000
ELCB 4P							
	EW125JAG-4P ⁽⁴⁾	30	15,20,30,40,50,60,75,100, 125	155	120	68	18,141,000
	EW125SAG-4P ⁽⁴⁾	36					21,639,000
	EW125RAG-4P ⁽⁴⁾	50					22,460,000
	EW160JAG-4P ⁽⁴⁾	30	125, 150, 160	165	140	68	28,227,000
	EW160SAG-4P ⁽⁴⁾	36	125, 150, 160				28,684,000
	EW160RAG-4P ⁽⁴⁾	50	125, 150, 160				30,597,000
	EW250JAG-4P ⁽⁴⁾	30	175, 200, 225, 250	165	140	68	29,986,000
	EW250SAG-4P ⁽⁴⁾	36	175, 200, 225, 250				31,985,000
	EW250RAG-4P ⁽⁴⁾	50	175, 200, 225, 250				34,267,000
	EW400RAG-4P ⁽⁴⁾	50	250, 300, 350, 400	257	185	103	82,206,000
	EW400HAG-4P ⁽⁴⁾	70	250, 300, 350, 400				96,501,000

Chú thích:

- (1): 15,30,100mA
- (2): 15,30,100/200mA
- (3): 30,100/200/500mA
- (4): 30,100/300/500/1000mA



Mã dòng rò bảo vệ:

- A: 15mA - B: 30mA - C: 100mA - D: 50mA
- J: 100/300/500/1000mA
- K: 100/200mA, 100/200/500mA, 100/200/500/1000mA

Phụ kiện MCCB	Mã hàng	Frame size sử dụng	Mô tả	Đơn giá VND
Khởi tiếp điểm phụ cho MCCB				
	BZ6WR10C	32, 50, 63, 100	G-Twin series	895,000
	BW9W1SB0	100	BW0 series	475,000
	BW9W1SG0	125, 250	G-Twin series / BW0 series	904,000
	BW9W1SHA	400, 630, 800	G-Twin series / BW0 series	1,371,000
	BX9W1SH0	100, 160, 250, 400, 630	BW-CF series	1,646,000
Khởi tiếp điểm cảnh báo cho MCCB				
	BZ6KL10C	32, 50, 63, 100	G-Twin series	1,044,000
	BW9K1SB0	100	BW0 series	475,000
	BW9K1SG0	125, 250	G-Twin series / BW0 series	364,000
	BW9K1SHA	400, 630, 800	G-Twin series / BW0 series	1,389,000
	BX9K1SH0	100, 160, 250, 400, 630	BW-CF series	1,646,000
Cuộn cắt cho MCCB				
	BZ6FA10C	32, 50, 63, 100 (G-Twin only)	110-120V AC/DC	1,529,000
	BZ6FK10C	32, 50, 63, 100 (G-Twin only)	200-240V AC	1,631,000
	BZ6FP10C	32, 50, 63, 100 (G-Twin only)	380-450V AC	2,009,000
	BZ6FR10C	32, 50, 63, 100 (G-Twin only)	24V AC/DC	1,585,000
	BW9FAB0	100 (BW0 only)	100-130V AC	4,577,000
	BW9FKB0	100 (BW0 only)	200-277V AC	4,568,000
	BW9FPB0	100 (BW0 only)	380-480V AC	4,568,000
	BW9FRB0	100 (BW0 only)	24VDC	4,568,000
	BW9FAG0	125, 160, 250	110-120V AC/DC	1,146,000
	BW9FKG0	125, 160, 250	200-240V AC	1,212,000
	BW9FPG0	125, 160, 250	380-440V AC	2,489,000
	BW9FRG0	125, 160, 250	24V AC/DC	1,492,000
	BW9FHA-A	400, 630, 800	110-220V AC/DC	2,946,000
	BW9FHA-P	400, 630, 800	380-550V AC	3,981,000
	BW9FHA-R	400, 630, 800	24-48V AC/DC	2,806,000
	BX9FAH0	100, 160, 250, 400, 630 (BW-CF only)	110-130V AC	1,995,000
	BX9FKH0	100, 160, 250, 400, 630 (BW-CF only)	220-240V AC	1,995,000
	BX9FRH0	100, 160, 250, 400, 630 (BW-CF only)	24V DC	1,995,000

Contactor	Mã hàng	kW	Dòng định mức (A)	Tiếp điểm phụ	Đơn giá VNĐ
Cuộn hút (coil) 110, 220VAC					
	SC-03	4	9	NO	378,000
	SC-0	5.5	12		455,000
	SC-05	5.5	12	NO + NC	476,000
	SC-4-0	7.5	16	NO	678,000
	SC-4-1	11	22		734,000
	SC-5-1	11	22	NO + NC	773,000
	SC-N1	15	32	2NO + 2NC	986,000
	SC-N2	18.5	40		1,148,000
	SC-N2S	22	50		1,967,000
	SC-N3	30	65		2,151,000
	SC-N4	40	80		3,181,000
	SC-N5A	55	105		3,472,000

Contactor	Mã hàng	kW	Dòng định mức (A)	Tiếp điểm phụ	Đơn giá VNĐ
Cuộn hút (coil) 220VAC/DC					
	SC-N6	60	125	2NO + 2NC	4,830,000
	SC-N7	75	150		6,718,000
	SC-N8	90	180		8,251,000
	SC-N10	110	220		10,771,000
	SC-N11	160	300		17,449,000
	SC-N12	220	400		22,859,000
	SC-N14	315	600		54,557,000
	SC-N16	440	800		80,049,000

Phụ kiện Contactor	Mã hàng	Mô tả	Đơn giá VNĐ
 	SZ-A02	Khởi tiếp điểm phụ 2NC SC-03->SC-N3	321,000
	SZ-A11	Khởi tiếp điểm phụ 1NO + 1NC SC-03->SC-N3	372,000
	SZ-A20	Khởi tiếp điểm phụ 2NO SC-03->SC-N3	471,000
	SZ-A22	Khởi tiếp điểm phụ 2NO + 2NC SC-03->SC-N3	463,000
	SZ-A31	Khởi tiếp điểm phụ 3NO + 1NC SC-03->SC-N3	662,000
	SZ-A40	Khởi tiếp điểm phụ 4NO SC-03->SC-N3	628,000
	SZ-AS1	Khởi tiếp điểm phụ 1NO + 1NC SC-03->SC-N3	334,000
	SZ-AS2	Khởi tiếp điểm phụ 1NO + 1NC SC-N4->SC-N12	594,000
	SZ-RM	Khóa liên động cơ Khí SC-03->SC-N3	611,000

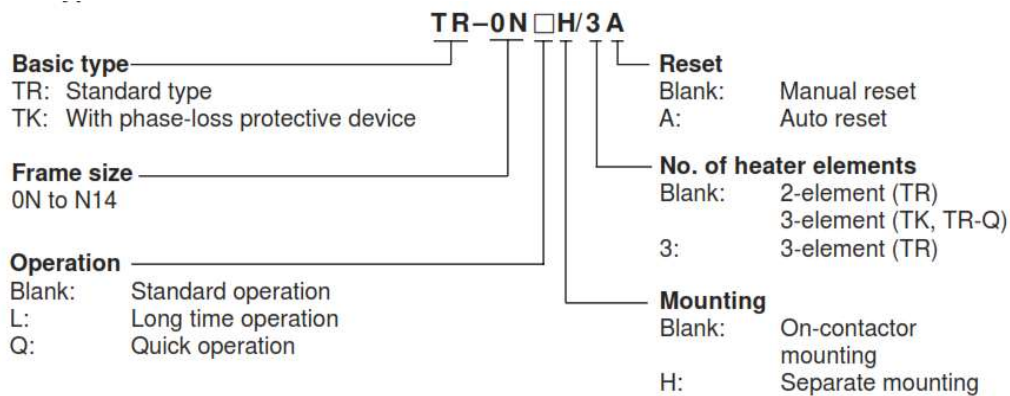

Role nhiệt	Mã hàng	Dùng cho	Khoảng điều chỉnh dòng (A)	Đơn giá (VNĐ)
	TR-0N	SC-03 SC-0 SC-05	0.24–0.36, 0.3–0.45, 0.36–0.54, 0.48–0.72, 0.64–0.96, 0.8–1.2, 0.95–1.45, 1.4–2.2, 1.7–2.6, 2.2–3.4, 2.8–4.2, 4–6, 5–8, 6–9, 7– 11, 9–13	350,000
	TR-5-1N	SC-4-0 SC-4-1 SC-5-1	9-13, 12-18, 16-22	403,000
	TR-N2	SC-N1 SC-N2	12 - 18, 18 - 26, 24 - 36	466,000
	TR-N3	SC-N2S SC-N3	24 - 36, 28 - 40, 34 - 50, 45 - 65	613,000
	TR-N5	SC-N4 SC-N5	53 - 80, 65 - 95	738,000
	TR-N6	SC-N6	85 - 125	1,156,000
	TR-N7	SC-N7	85 - 125, 110 - 160	1,856,000
	TR-N8	SC-N8	110 - 160, 125 - 185	2,222,000
	TR-N10	SC-N10	125 - 185, 160 - 240	3,230,000
	TR-N12	SC-N11 SC-N12	160 - 240, 200 - 300, 240 - 360, 300 - 450	(*)
	TR-N14	SC-N14	300 - 450, 400 - 600	(*)

(*) : Liên hệ đại lý khi có dự án



Motor CB	Mã hàng	Icu tại AC400V (kA)	Công suất (KW)	Khoảng điều chỉnh dòng (A)	Đơn giá VNĐ
Motor CB loại tiêu chuẩn					
	BM3RSB-P40	100	0.09	0.25...0.4	1,205,000
	BM3RSB-P63	100	0.12 & 0.18	0.40...0.63	1,205,000
	BM3RSB-001	100	0.25	0.63...1	1,216,000
	BM3RSB-1P6	100	0.37 & 0.55	1...1.6	1,166,000
	BM3RSB-2P5	100	0.75	1.6...2.5	1,186,000
	BM3RSB-004	100	1.1 & 1.5	2.5...4	1,186,000
	BM3RSB-6P3	100	2.2	4...6.3	1,186,000
	BM3RSB-010	100	3 & 4	6...10	1,186,000
	BM3RSB-013	50	5.5	9...13	1,210,000
	BM3RSB-016	25	7.5	11...16	1,201,000
	BM3RSB-020	25	9	14...20	1,201,000
	BM3RSB-025	25	11	19...25	1,146,000
	BM3RSB-032	25	15	24...32	1,154,000



Phụ kiện MMS	Mã hàng	Mô tả	Đơn giá VNĐ
	BZ0WIA	Khối tiếp điểm phụ cho BM3R, BM3V 1NO, gắn phía trước	92,000
	BZ0WIB	Khối tiếp điểm phụ cho BM3R, BM3V 1NC, gắn phía trước	92,000
	BZ0KIA	Khối tiếp điểm cảnh báo cho BM3R, BM3V 1NO, gắn phía trước	98,000
	BZ0KIB	Khối tiếp điểm cảnh báo cho BM3R, BM3V 1NC, gắn phía trước	98,000

ACB	Mã hàng	Dòng định mức (A)	Icu tại AC400V (kA)	Đơn giá VND
ACB 3P, loại cố định (Fix)				
	BT3-1600P/30630E	630A	65kA	(*)
	BT3-1600P/30800E	800A		(*)
	BT3-1600P/31000E	1000A		(*)
	BT3-1600P/31250E	1250A		75,599,000
	BT3-1600P/31600E	1600A		81,888,000
	BT3-2500P/32000E	2000A		94,650,000
	BT3-2500P/32500E	2500A		113,655,000
	BT3-2500HP/32000E	2000A	85kA	109,373,000
	BT3-2500HP/32500E	2500A		127,294,000
	BT3-4000P/33200E	3200A		137,817,000
	BT3-4000P/34000E	4000A	100kA	201,962,000
	BT3-4000HP/33200E	3200A		251,108,000
	BT3-4000HP/34000E	4000A	396,289,000	
	BT3-6300P/35000E	5000A	120kA	1,202,393,000
	BT3-6300P/36300E	6300A		1,526,042,000
ACB 4P, loại cố định (Fix)				
	BT3-1600P/40630E	630A	65kA	(*)
	BT3-1600P/40800E	800A		(*)
	BT3-1600P/41000E	1000A		(*)
	BT3-1600P/41250E	1250A		86,534,000
	BT3-1600P/41600E	1600A		96,069,000
	BT3-2500P/42000E	2000A		110,629,000
	BT3-2500P/42500E	2500A		138,988,000
	BT3-2500HP/42000E	2000A	85kA	118,407,000
	BT3-2500HP/42500E	2500A		147,018,000
	BT3-4000P/43200E	3200A		160,484,000
	BT3-4000P/44000E	4000A	100kA	264,445,000
	BT3-4000HP/43200E	3200A		310,131,000
	BT3-4000HP/44000E	4000A	481,829,000	
	BT3-6300P/45000E	5000A	120kA	1,481,943,000
	BT3-6300P/46300E	6300A		1,904,050,000

(*) : Liên hệ khi có dự án

Lưu ý :

1. Giá ACB Frame 1600 cần cộng thêm giá Bộ nguồn (PA1/ PA2/ PD1)
2. Giá ACB ở trên bao gồm tiếp điểm phụ, shuntrip, motor nạp, cuộn đóng

ACB	Mã hàng	Dòng định mức (A)	Icu tại AC400V (kA)	Đơn giá VND
ACB 3P, loại kéo rút (Draw out)				
	BT3-1600X/30630E	630A	65kA	(*)
	BT3-1600X/30800E	800A		(*)
	BT3-1600X/31000E	1000A		(*)
	BT3-1600X/31250E	1250A		(*)
	BT3-1600X/31600E	1600A		(*)
	BT3-2500X/32000E	2000A		(*)
	BT3-2500X/32500E	2500A	85kA	(*)
	BT3-2500HX/32000E	2000A		(*)
	BT3-2500HX/32500E	2500A		(*)
	BT3-4000X/33200E	3200A		(*)
	BT3-4000X/34000E	4000A	100kA	(*)
	BT3-4000HX/33200E	3200A		(*)
	BT3-4000HX/34000E	4000A	120kA	(*)
	BT3-6300X/35000E	5000A		(*)
	BT3-6300X/36300E	6300A		(*)
ACB 4P, loại kéo rút (Draw out)				
	BT3-1600X/40630E	630A	65kA	(*)
	BT3-1600X/40800E	800A		(*)
	BT3-1600X/41000E	1000A		(*)
	BT3-1600X/41250E	1250A		(*)
	BT3-1600X/41600E	1600A		(*)
	BT3-2500X/42000E	2000A		(*)
	BT3-2500X/42500E	2500A	85kA	(*)
	BT3-2500HX/42000E	2000A		(*)
	BT3-2500HX/42500E	2500A		(*)
	BT3-4000X/43200E	3200A		(*)
	BT3-4000X/44000E	4000A	100kA	(*)
	BT3-4000HX/43200E	3200A		(*)
	BT3-4000HX/44000E	4000A	120kA	(*)
	BT3-6300X/45000E	5000A		(*)
	BT3-6300X/46300E	6300A		(*)

(*) : Liên hệ khi có dự án

Lưu ý:

1. Giá ACB Frame 1600 cần cộng thêm giá Bộ nguồn (PA1/ PA2/ PD1)
2. Giá ACB ở trên đã bao gồm tiếp điểm phụ, shuntrip, motor nạp, cuộn đóng.

Phụ kiện ACB BT3	Mã hàng	Mô tả	Đơn giá VND
	A35	A35 (LSI Protection)	(*)
	A36	A36 (LSI Protection)	6,019,000
	R11	UVT (AC220V-AC240V) tác động tức thời	8,165,000
	R12	UVT (AC380V-AC415V) tác động tức thời	8,165,000
	R21	UVT (AC220V-AC240V) thời gian trễ điều chỉnh được (0.5s, 1s, 2s, 3s)	12,245,000
	R22	UVT (AC380V-AC415V) thời gian trễ điều chỉnh được (0.5s, 1s, 2s, 3s)	12,245,000
	Q1	Bộ khóa bao gồm 1 khóa 1 chìa	4,592,000
	Q2	Bộ khóa bao gồm 2 khóa 1 chìa	7,143,000
	Q3	Bộ khóa bao gồm 3 khóa 2 chìa	9,184,000
	M1	Motor nạp BT3-1600	(*)
	M2	Motor nạp BT3-2500	(*)
	M3	Motor nạp BT3-4000,6300	(*)
	MW1	Khóa liên động 2 ACB bằng cáp	30,618,000
	MB1	Khóa liên động 2 ACB bằng cần	30,618,000
	MW2	Khóa liên động 3 ACB bằng cáp (2500AF, 4000AF,6300AF)	40,820,000
	MB2	Khóa liên động 3 ACB bằng cần (2500AF, 4000AF,6300AF)	40,820,000
	B3	Tấm chắn pha cho ACB loại 3P	1,225,000
	B4	Tấm chắn pha cho ACB loại 4P	1,837,000
	L	Khóa nút bấm	1,903,000
	CM	Bộ đếm	1,428,000
	AS1	Bộ điều khiển ATS (Đã bao gồm cáp)	108,177,000
	PA1	Bộ nguồn AC220-240V	3,061,000
	PA2	Bộ nguồn AC380-415V	3,061,000
	PD1	Bộ nguồn DC24V	6,123,000

Lưu ý :

Giá phụ kiện áp dụng khi mua kèm ACB, mua lẻ cần check lại giá với đại lý phân phối